

HEWLETT  PACKARD

AUTOMATIC MEASUREMENT SYSTEMS
APPLICATIONS SERIES

Viggen Avionics Support

A Solution to a Measurement Problem for THE ROYAL SWEDISH AIR FORCE



"Two-man test crew about to run performance check of Viggen avionics at RSAF operational base at Satenas, Sweden. January conditons make rapid test procedures very welcome."

Automated Support for an Advanced Aircraft

Sweden's "Thunderbolt," the Viggen, is a highly advanced supersonic, multipurpose combat aircraft with STOL capability.

In determining the design of the Viggen, it was decided to adopt a single-seat configuration, both to reduce aircraft cost and to minimize the flight crew manpower that would be needed. This meant that the aircraft had to be easy to fly under all combat conditions, so the maximum degree of automatic capability was designed into the Viggen. This in turn demanded highly sophisticated avionics test capability in the Viggen's ground support: at the flight line, and at the back-up workshop and depot levels.

STOL capability was necessary because the Swedes felt their principal defense aircraft should be flyable from ordinary main roads, avoiding the need for vulnerable conventional airfields. Therefore ground support for the Viggen had to be as deployable as the aircraft.

At the same time, the Royal Swedish Air Force was adamant that the aircraft and its support should fit within its existing pattern of maintenance, which was based on a minimum of military personnel in the field, subject to frequent dispersal, and backed up by a strong civilian base organization.

For these reasons, it was decided to adopt computer-controlled Automatic Test Equipment at all three levels of support — at the depot and workshop, and even at the flight line, where conditions for the ATE would frequently be rugged.

These decisions on Viggen ground support were made concurrently with the design decisions on the aircraft itself, since the Viggen was planned as a complete system — "System 37". This included four versions of the aircraft: attack (AJ 37), reconnaissance (S 37), fighter (JA 37) and a two-seat trainer (SK 37). The intent was that the ATE should test all variants of the avionics for a given version of the Viggen, with no changes other than the test programs and test adapter. And even for different versions of the Viggen, only a minor change in the test instruments complement should be necessary.

The attack and trainer versions of the Viggen are now operational, and the avionics support ATE has itself been tested under practical working conditions at the squadron level.

Use of computer-controlled ATE has brought tremendous reductions in test times over manual testing — of particular importance, of course, in flight line support, where maximum aircraft availability is of paramount importance. In practice, the Royal Swedish Air Force has realized *overall reductions in test times of 70% (over manual testing), and in many cases as much as 90%*. Besides the time and cost saving, ATE has reduced the number of support people required, and this, of course, is also an important logistics consideration.

Much of the skill involved in carrying out the many different test procedures for the Viggen avionics is captured in the computer software, conveniently contained in interchangeable disc cartridges. This feature is of particular value in

Viggen is equipped with terrain-following radar permitting speeds greater than Mach 1 at very low altitude. High altitude speed capability is over Mach 2.



flight-line testing, since it allows highly-sophisticated test procedures to be handled by people having relatively little technical training. At the same time, computer control of the test procedures ensures accurate, consistent testing — something that cannot be expected with manual testing under the rigors of field conditions. A further benefit is that, to switch from testing one Viggen avionics variant to another, requires no more than slipping the appropriate cartridge and interface patch panel into the ATE.

Yet another advantage of computer-controlled ATE is that it enables self-test procedures to be contained also in computer software. For example, a functional performance verification of the flight-line ATE is performed in about 2½ minutes. A more detailed self-test identifies a faulty tester replaceable unit in approximately 10 minutes.

The Royal Swedish Air Force chose to use ATE comprised of commercial instrumentation. This has yielded substantial cost savings over custom-engineered equipment, along with proven performance and established documentation and spares support. It also made it easier to obtain a high degree of commonality in the various levels of ATE, facilitating carry-over of operator expertise and minimizing their own overall logistics support for the ATE.

Hewlett-Packard is proud to have supplied the ATE to support the Viggen avionics in development, production, and all levels of operational support. The following pages describe how HP automatic test systems are being used by the Royal Swedish Air Force, by FFV-CVA,* a maintenance depot and technical support organization for the Swedish Armed Forces, and by Saab-Scania, the prime contractor on the Viggen program.

*Forenade Fabriksverken, Arboga base

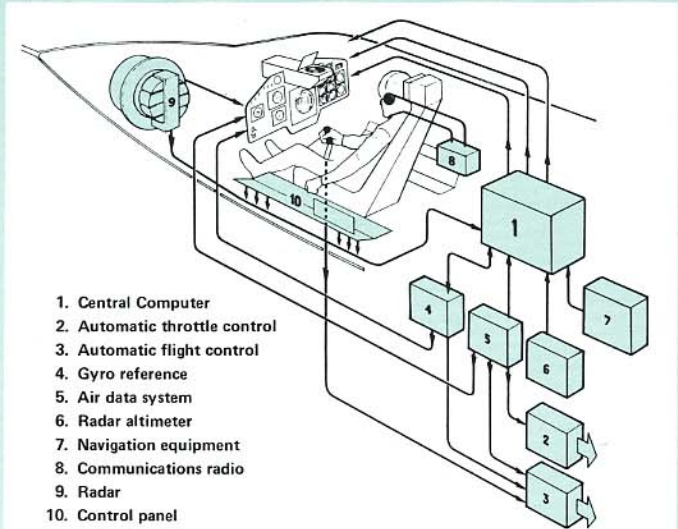

In order to reduce the pilot's workload, most of the routine flight, navigation, communication, and fire control functions are placed under control of a central digital computer. The computer provides essential information to the pilot in a head-up display (a transparent display in the pilot's line of sight). The head-up display eases the pilot's tasks during take-off, low-altitude navigation, intercept guidance, fire control and landing.

In addition to these aids, operation of the various avionics systems is continually monitored, activating good/bad status indications to the pilot.

The electronic equipment allows full use of the performance capability of the Viggen, independent of weather or visibility, throughout its entire speed-altitude envelope, to accomplish its military objectives. However, the aircraft can, if necessary, be flown safely without the aid of the electronic equipment.

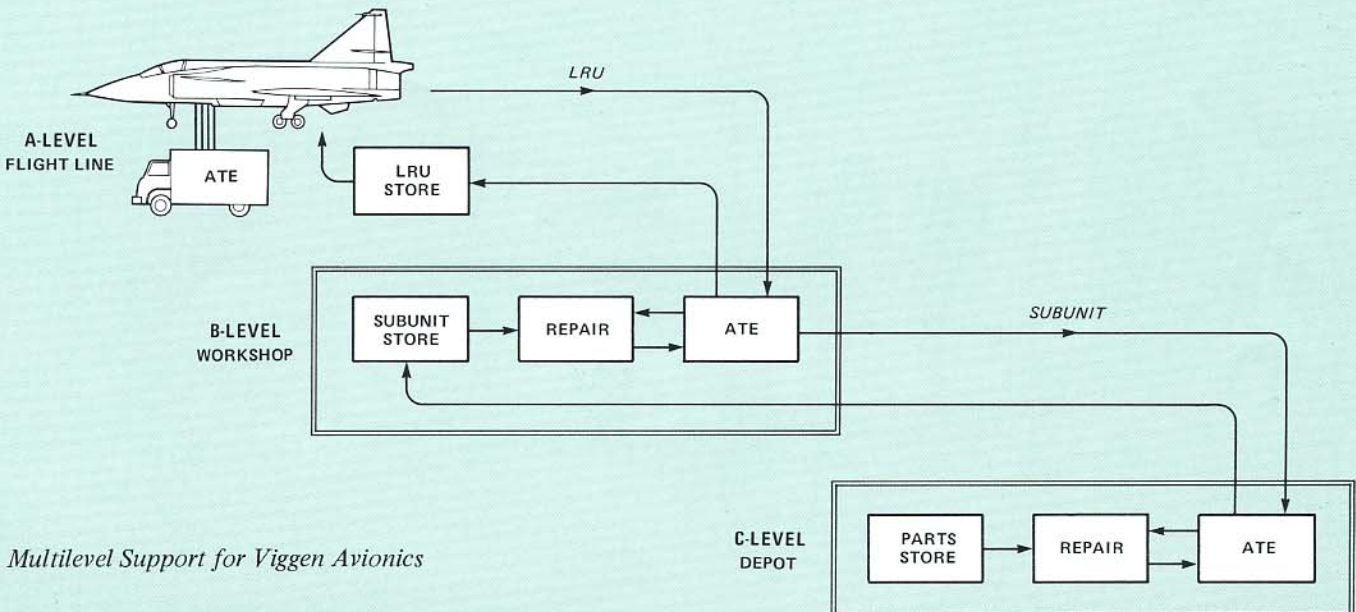

Multilevel Support for Viggen Avionics

Flight-Line Support

Ground support equipment for Viggen's avionics is contained in two vans (photo below).

One van supplies electrical and hydraulic power, and cooling air for the avionic equipment. The other van contains the A-level automatic test system, along with special test instruments for some portions of the radar and for pneumatic equipment.

Connections are made to the entire Viggen avionics via five main cables carrying a total of 1,000 test leads, and a few smaller cables and pneumatic hoses.

The autotester is used for identifying a faulty Line Replaceable Unit in the event of an avionics malfunction, and for periodic complete field checkout of all the Line Replaceable Units in the Viggen. The A-level tester is capable of testing about 100 different LRUs. The autotester also provides a convenient means of loading the flight program into the Viggen CK 37 avionics computer.

As the situation requires, the operator calls up the appropriate test program from the autotester's disc memory, using a keyboard on the autotester control panel. Another button

initiates the test; test stimuli are then applied automatically, and responses measured and compared with established tolerances. The computer printout identifies a faulty LRU, and the test it has failed. Should the operator wish to make a confidence check on the autotester before replacing the LRU, he simply initiates the self-check program, which will confirm the autotester status in approximately two and one-half minutes.

Identification of a faulty LRU normally takes only a few minutes, since the on-board functional status indicators will have given the pilot an indication of which avionic system is not operating correctly. Even a complete checkout of all the Line Replaceable Units on the Viggen, representing many thousands of tests, can be done in a few hours. Previous manual test methods would require days to cover the same ground.

Besides dramatically cutting test times in the field — where fast aircraft turnaround is vital — automatic testing ensures consistent, accurate testing. No longer is flight line support dependent on highly-skilled ground personnel capable of carrying out intricate tests with manual instruments.

Flight-line testing. Van on left contains A-level automatic test system. Van on right supplies cooling air, electrical and hydraulic power to Viggen. It also supplies electrical power to the test van.



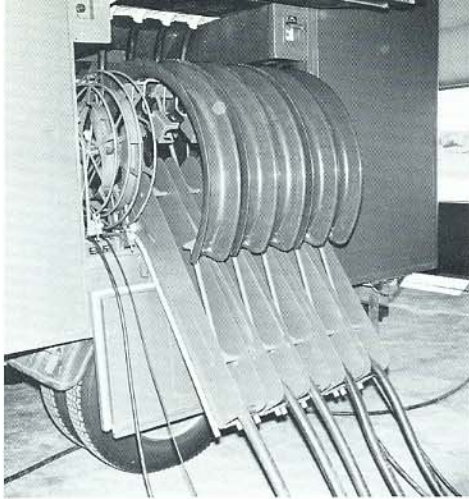

Five main 200-conductor cables for testing Viggen avionics are supported on roll-out frames in A-level van.

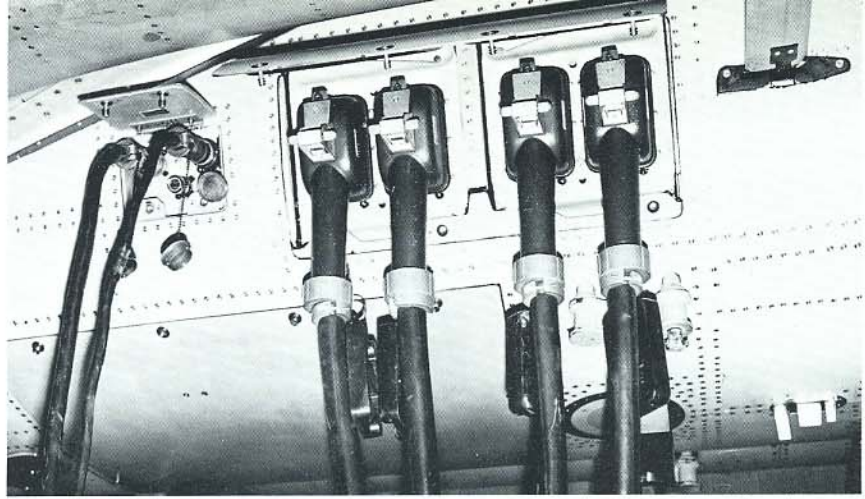

Test connections to A-level autotester are made through these four connectors, plus similar fifth connector located behind another, nearby, access panel.

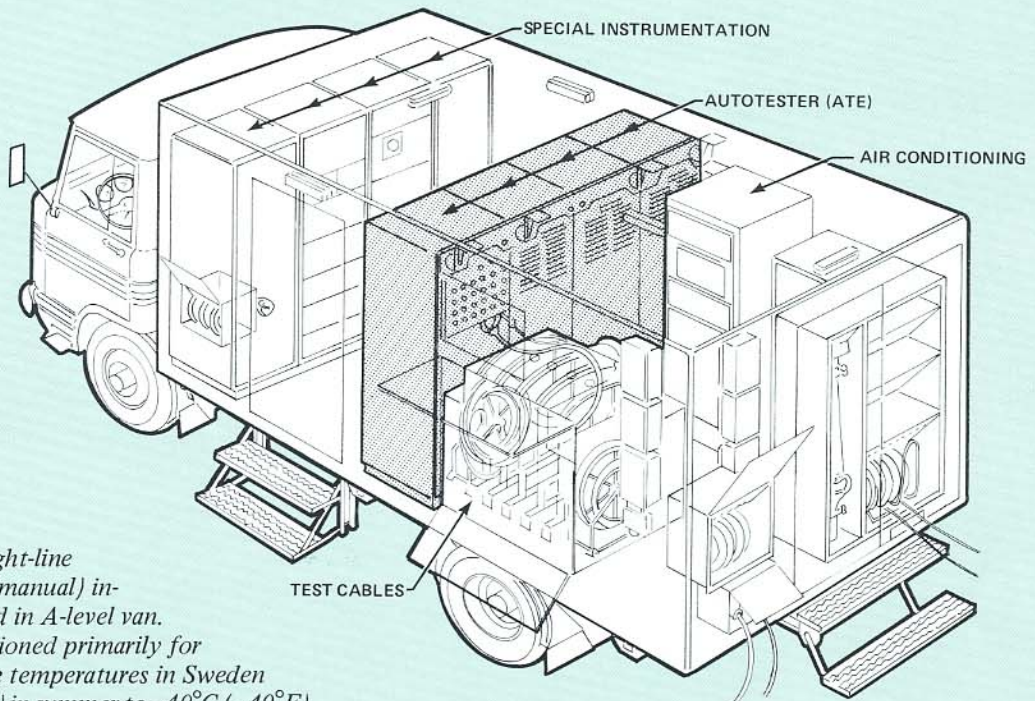

Diagram shows how flight-line autotester and special (manual) instrumentation is housed in A-level van. Autotester is air-conditioned primarily for operator comfort, since temperatures in Sweden range from 30°C (86°F) in summer to -40°C (-40°F) in winter. Entire "box" housing test equipment can be removed bodily from van chassis for maintenance and calibration.

Maintenance technician removes faulty LRU. Almost 25% of Viggen skin is covered by hatches to simplify equipment accessibility. LRUs are field-replaceable without adjustment.



Ground support technician calls up test program at autotester control panel.



Workshop and Depot Support

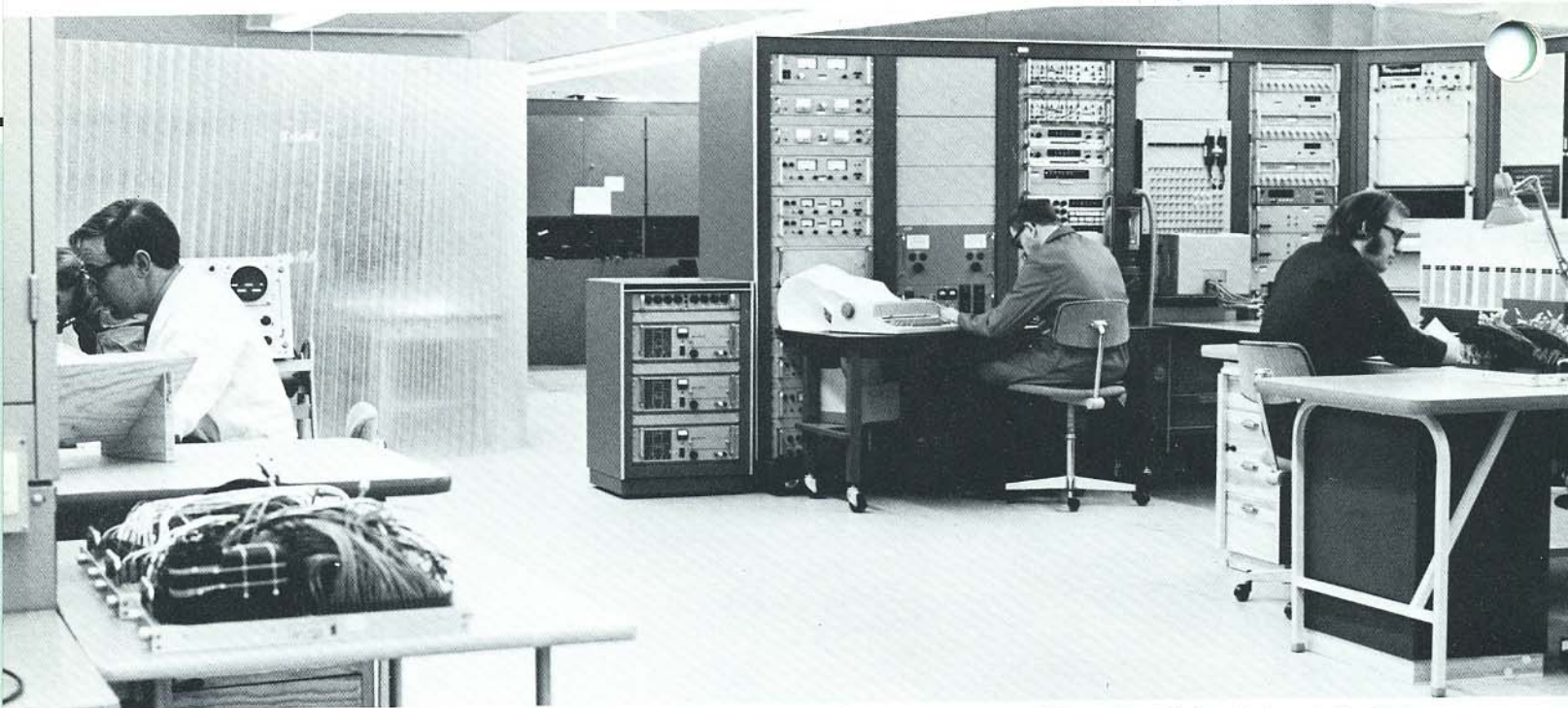

B-level test system at workshop. Repair bench is on left of photo.

Line Replaceable Units returned to the workshop for repair are tested on an automatic test system similar in principle to the A-level system, but considerably expanded in capability with additional stimulus and measurement instruments.

The LRU is connected to the system through a plug-in interface adapter (photo below). As with the flight-line system, programs are stored on the disc memory and are called up from the system control panel.

The computer printout tells the operator which LRU sub-unit is at fault and the test it has failed. Armed with this information, it takes only minutes for the repair technician to

replace the faulty sub-unit. The LRU is then retested and, if satisfactory, returned to flight-line support. Besides its use for checkout of LRUs, the B-level system is utilized for developing LRU test programs.

Backing up the workshop ATE, the depot ATE tests repairable LRU sub-units and portions of the Viggen avionics requiring test capability beyond that of the B-level system. Essentially, C-level ATE consists of a system similar to the B-level tester but with expanded microwave capability (photo below), and a separate system for testing the avionics digital computer.

Technician plugs LRU test adapter into interface panel on B-level test system.



Expanded version of B-level test system is used for microwave testing at depot.

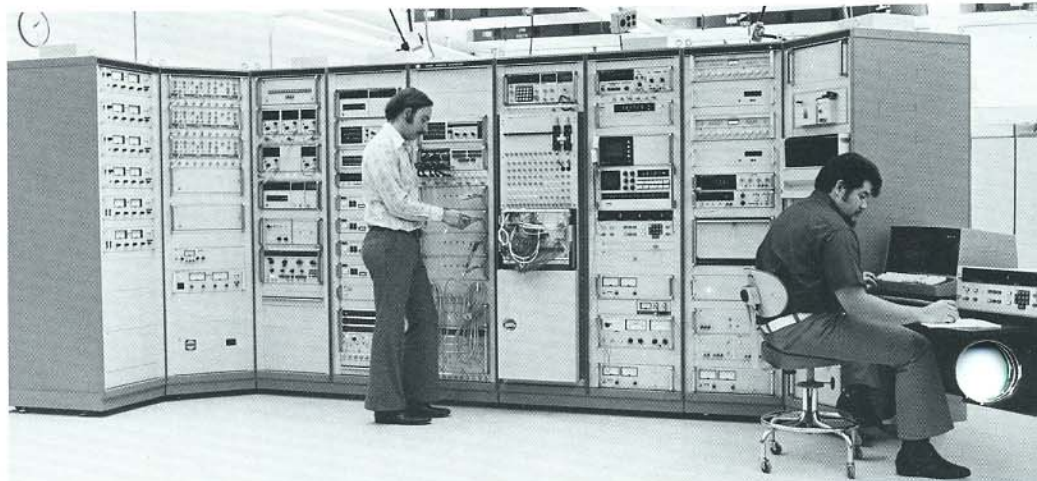

Software Support

Strong software support is vital to make computerized automatic testing completely effective.

Saab-Scania is responsible for developing the original test programs for the A-level tester (see page 9), while CVA handles all updating and field support of the Viggen automatic test software for the flight line (A-level) and all programming for the workshop and depot testers (B- and C-level). Test programs for all levels of ATE are written in HP ATS BASIC, a simple, conversational language convenient for test personnel.

When a portion of the Viggen avionics is modified, the test program is revised by a CVA technician (photo a).

Because of the volume of software support activity at CVA, all revised programs are punched on tape for the technicians, then rapidly checked for programming accuracy on an HP computer system dedicated to program production (photo b). Programs are printed out on a high-speed line printer, with error messages for any syntax errors. These are corrected by the technician and the program is checked again. When syntactically correct, the program is recorded on a disc cartridge and is then ready for a "safety check".

The safety check ensures that the test program supplies the proper stimuli at the appropriate test points, and will not damage the Line Replaceable Unit. This is accomplished by running the program on an A-level test system, but routing all 1000 test leads to a 1000-point terminal panel (photo c), instead of to an LRU. This allows the technician to run the program in stages, stopping it where necessary to check the programmed stimuli with manual test instruments.

Any errors found can be corrected on the spot by the test technician, using the conversational feature of ATS BASIC. The safety-checked program, recorded on the disc cartridge, is ready for check-out with real hardware.

Final verification of the test program is accomplished with an actual Line Replaceable Unit installed in a test "rig", together with an A-level test van. The rig (photo d) simulates the avionics installation in the Viggen, with all the LRUs located in the same physical relationship and interconnected by similar cable harnesses. The rig is connected to the A-level test van via cables and connectors identical to those used with the aircraft.

During this final check, any errors can be corrected immediately by the test technician on the A-level tester (photo e). The completely verified, updated test program is then duplicated on to disc cartridges which are shipped to the field, and the update is complete.

The simplicity and convenience of HP ATS BASIC software enables CVA to use the people most knowledgeable of the test problems to revise test programs, rather than a staff of specialist programmers. It has also allowed CVA to become completely independent of the equipment supplier, even to the extent of training new technicians for software support.

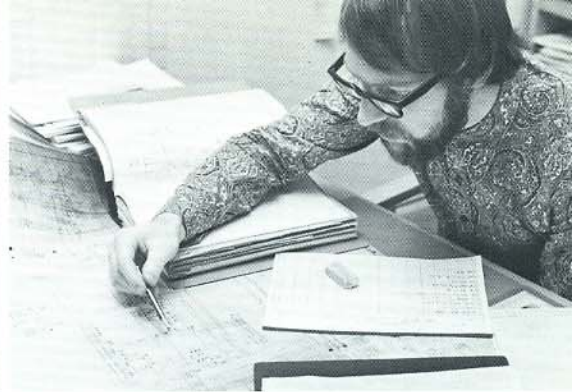

a



b



c

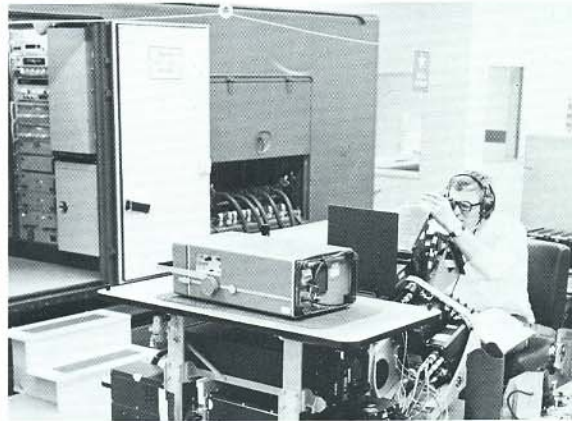

d



e

Training

Training for Viggen ground support personnel takes place at the RSAF Training Center at Halmstad.

General maintenance technicians attend a four-week training course on the Viggen avionics. However, only three days of this course are devoted to use of the A-level tester – a tribute to its simplicity of operation. In this abbreviated course, students learn general system principles, communication with the system in the ATS BASIC programming language, and system operating procedures for identifying faulty Line Replaceable Units under field service conditions.

Electronic specialists attend an advanced course of approximately 30 weeks, of which five weeks are spent on the autotester. This in-depth training explores the system's stimulus and measurement capabilities in relation to the aircraft avionics. Control of the test instrumentation through the computer is covered fully, such that students are able to handle non-routine avionics malfunctions and test problems.

Special courses were provided by Hewlett-Packard to train RSAF and CVA instructors in ATE operation, programming, and maintenance.

At the Halmstad Training Center, the instructor explains theory of operation of the computer-controlled autotester to an advanced class.

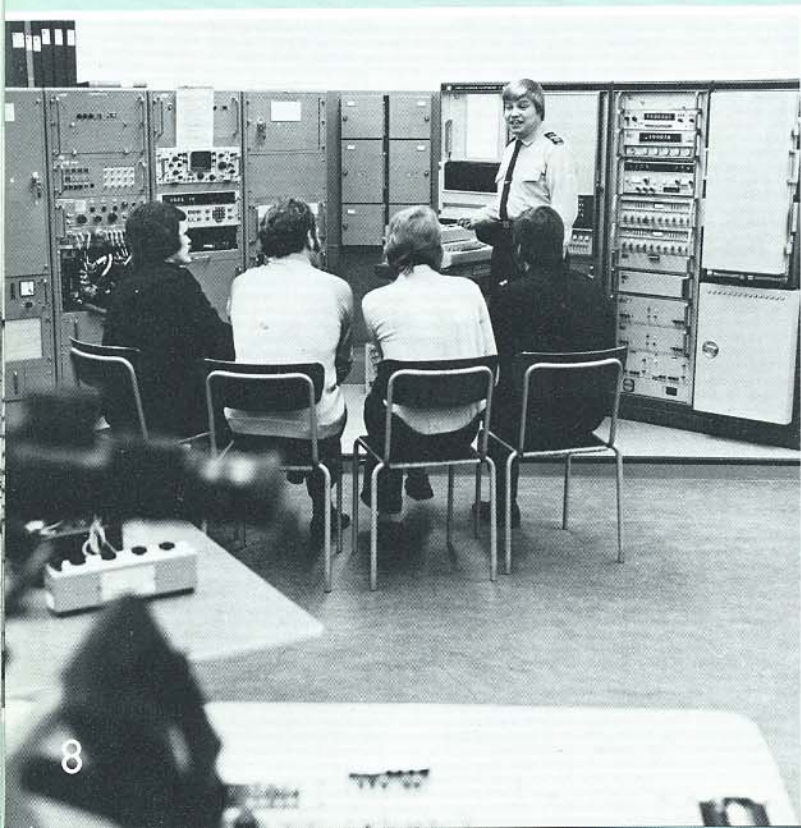

In a typical laboratory session, the instructor is describing operation of the autotester to a group of maintenance technicians. The same test instrumentation is used as in the A-level van, except it is mounted on a platform for convenience. LRUs are installed in a rig, similar to the rig at CVA pictured on page 7. (Head-up display of test rig is in foreground.)

Development and Production Test

An HP automatic test system, in the A-level configuration, is used at the Saab-Scania factory for developing the original test programs for the various versions of the Viggen avionics (photo right).

The test specialist writes the test programs in ATS BASIC, working from the specifications for the avionics modules. The programs are then checked out on a test rig simulating the aircraft installation. However, prior to running the program with an actual LRU, test stimuli are manually measured at the test connector, to ensure they are within acceptable limits. The conversational nature of HP ATS BASIC enables the program to be stopped at any desired point, and corrections made as necessary before proceeding.

During final checkout of the completed aircraft, the avionics are verified using A-level test systems mounted on roll-around platforms (photo below). If problems are encountered with an LRU, it is removed and installed in a production test rig and checked out with an A-level system. (The production rig is similar to the avionics development rig. The former is configured for the avionics in current production while the latter reflects new avionic components in development.)

Portion of Viggen final production test area at the Saab-Scania Aerospace Division at Linköping. A-level test systems are mounted on roll-around platforms. Saab-Scania also uses an A-level van for convenient checkout of aircraft during flight testing.

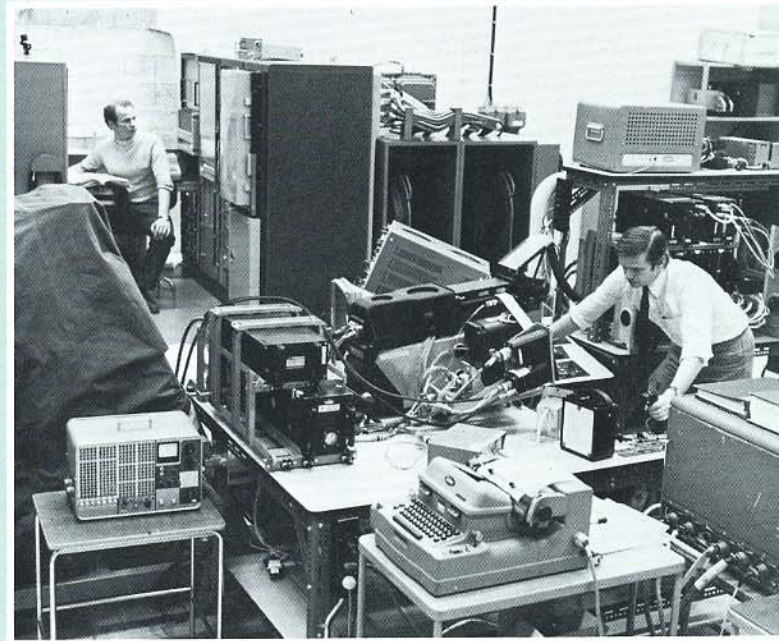

Rig and A-level test system are used at Saab-Scania to develop and check out test programs for new avionic units.

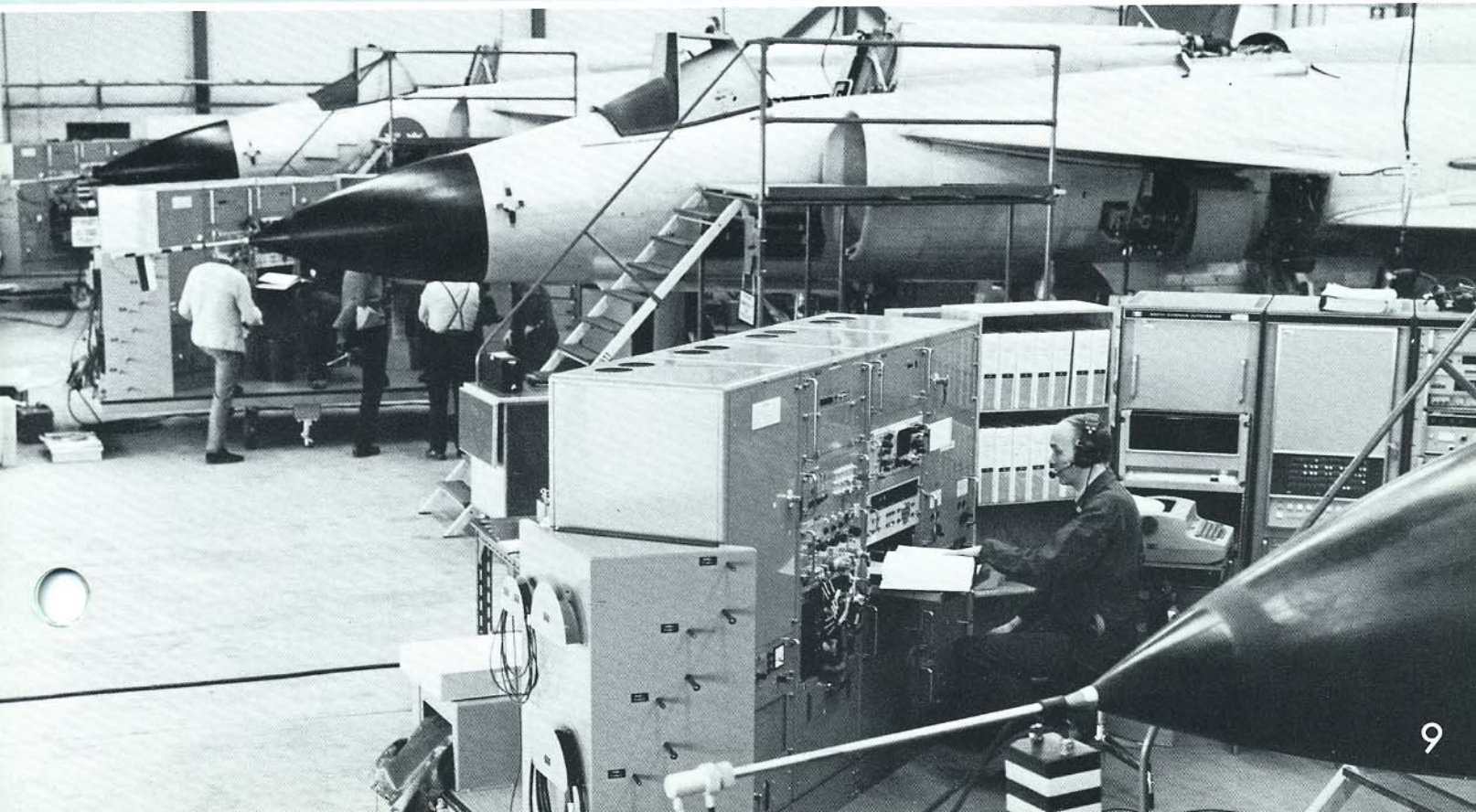

Flight-Line Automatic Test Equipment

Hewlett-Packard support for the Viggen AJ 37 comprises almost forty automatic test systems. HP systems are used for maintenance testing at the flight line, workshop and depot. They are used for production testing of the Viggen avionics. They are also used for software development and maintenance. Deliveries commenced in early 1970, concluding with delivery of the microwave test system for depot level support, in 1973.

The equipment supplied to the RSAF, FFV-CVA, and Saab-Scania is typical of HP 9500 Series Automatic Test Systems. These systems feature standard commercial instruments for stimulus, measurement, computation, operator communication, and system control. Use of test instruments in regular

production yields proven performance specifications, reliability history, standard commercial spare parts, established prices, and shorter delivery. Most test requirements for avionics (and other) equipment can be entirely or largely met with an HP 9500 automatic test system.

The HP 9500-type system used for A-level support is illustrated on these two pages. The larger systems for B-level and C-level support use the same series computer, disc memory, control panel, and essentially the same switching and interface approach to the unit-under-test. Expanded stimulus and measurement capabilities are achieved with additional standard test instruments. The same programming language (HP ATS BASIC) and software operating system – TODS (Test-Oriented Disc System) is used on all systems.

Test Identification Number Operation to be performed by test operator Measured value, or value entered by operator

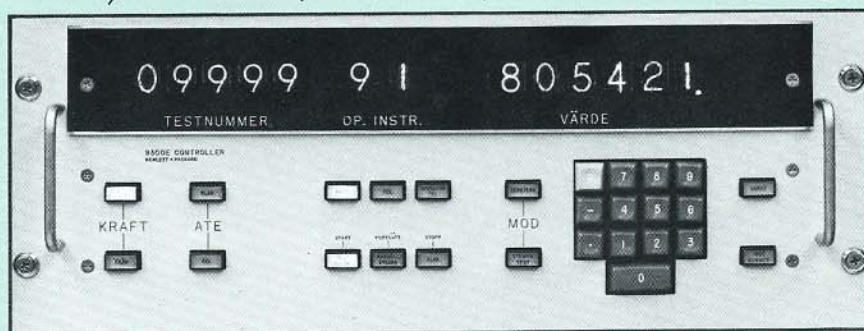

Operator controls for interaction with test program

Keyboard for selecting program and for entering numbers needed by program

Control Panel, used in A-, B- and C-level systems. Panel is engraved with Swedish titles for convenience of operators. All systems have "operator" and "supervisor" operating modes, selected by key-operated switch on equipment rack. In "operator" mode, user can only call up and execute test programs. In "supervisor" mode, user can alter and develop test programs. (Current commercial version of system control panel includes the key-operated operator/supervisor mode switch.)

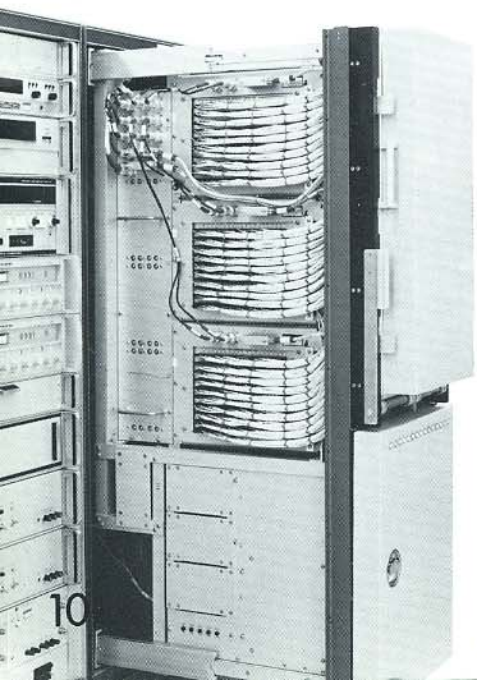

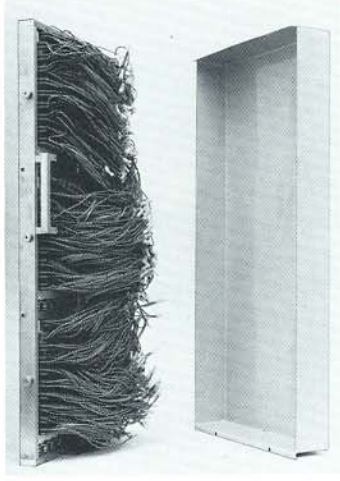

Detachable patch panel is used to determine point-to-point interconnections between ATE and aircraft avionics. For convenience, panels are usually prewired and interchanged to adapt ATE from one version of avionics to another. A cover is mounted on panel to protect wires. A typical patch panel for testing the Viggen avionics has almost 5,000 patch cords.

To ensure that correct program and patch panel are used for specific avionics configuration to be tested, "code connector" (plug-in connector with certain pins grounded) in aircraft identifies avionics configuration. Small section of patch panel is similarly used to establish identification code. Test program interrogates aircraft code connector and patch panel to determine they are correct for tests contained on that disc cartridge.

Photo shows patch panel and modular switch assembly rolled forward from rack for access. All instrumentation in A-level ATE is accessible from the front, for easy maintenance. Connections to aircraft are concentrated at one panel at rear of rack.

*Control Panel
(Normally mounted in rack facing ATE in van)*

*Connections between ATE and
1000 test points on Viggen are
made through this patch panel.*

*Panel is interchangeable to allow
testing different versions of
Viggen avionics.*

*Stimulus and Measurement
Instruments*

*Disc Memory
for storage of test programs*

Test Printout

DC Stimuli

*Computer for System Control
(8K, 16-bit memory,
later field-expanded to 16K)*

*Input/Output Extender
(System utilizes 21 of 32 channels available)*

*Modular switching for routing of stimulus and response signals to instruments.
Switching provides 600 3-wire measurement channels and 176 isolated 2-wire stimulus channels.*

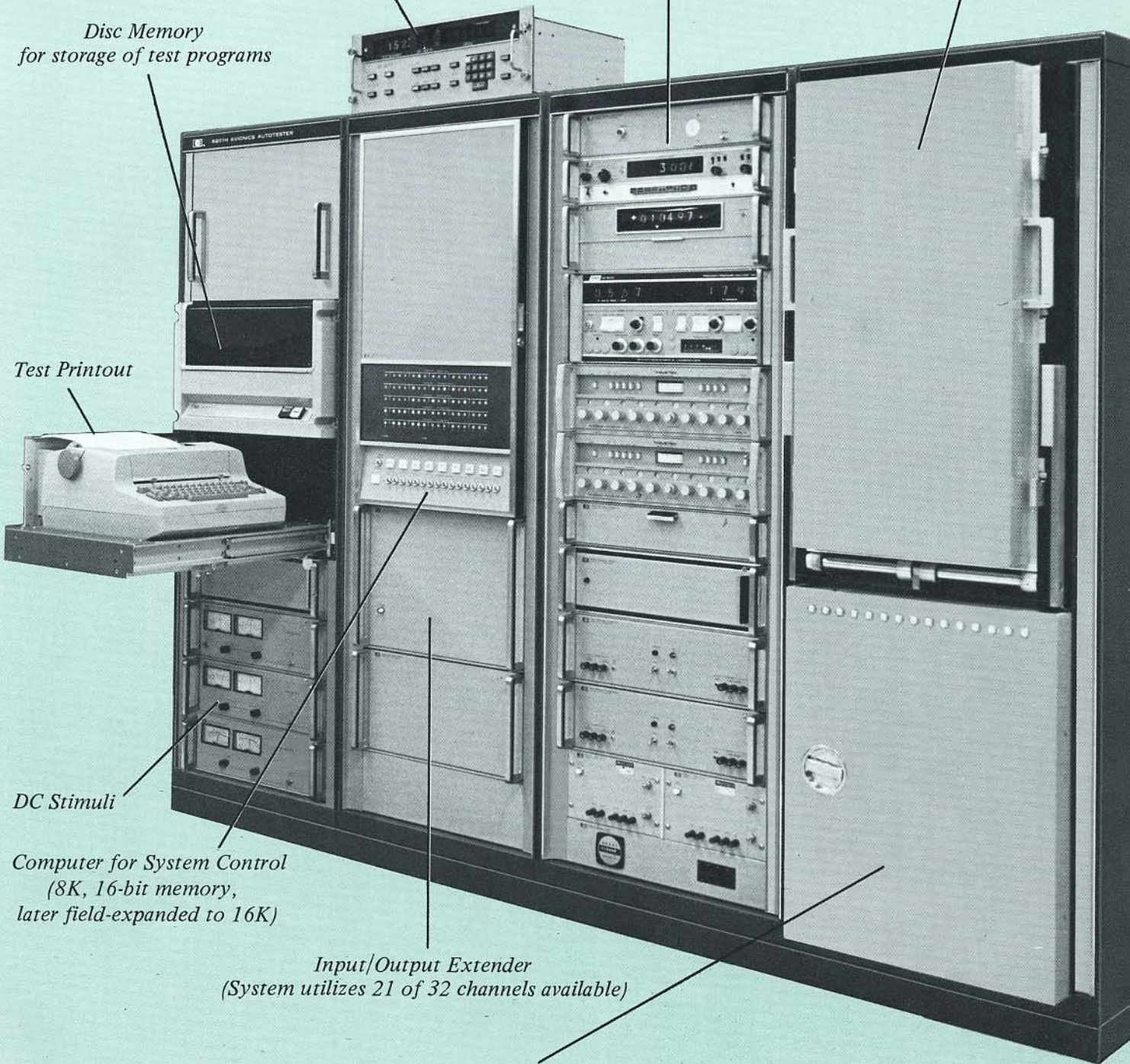

A Viggen takes off from a road base. The Viggen can take off and land in approximately 500 meters (roughly 1,600 feet) – less than half the distance normally required by conventional combat aircraft. Auxiliary road-base may be only 12 to 14 meters wide.

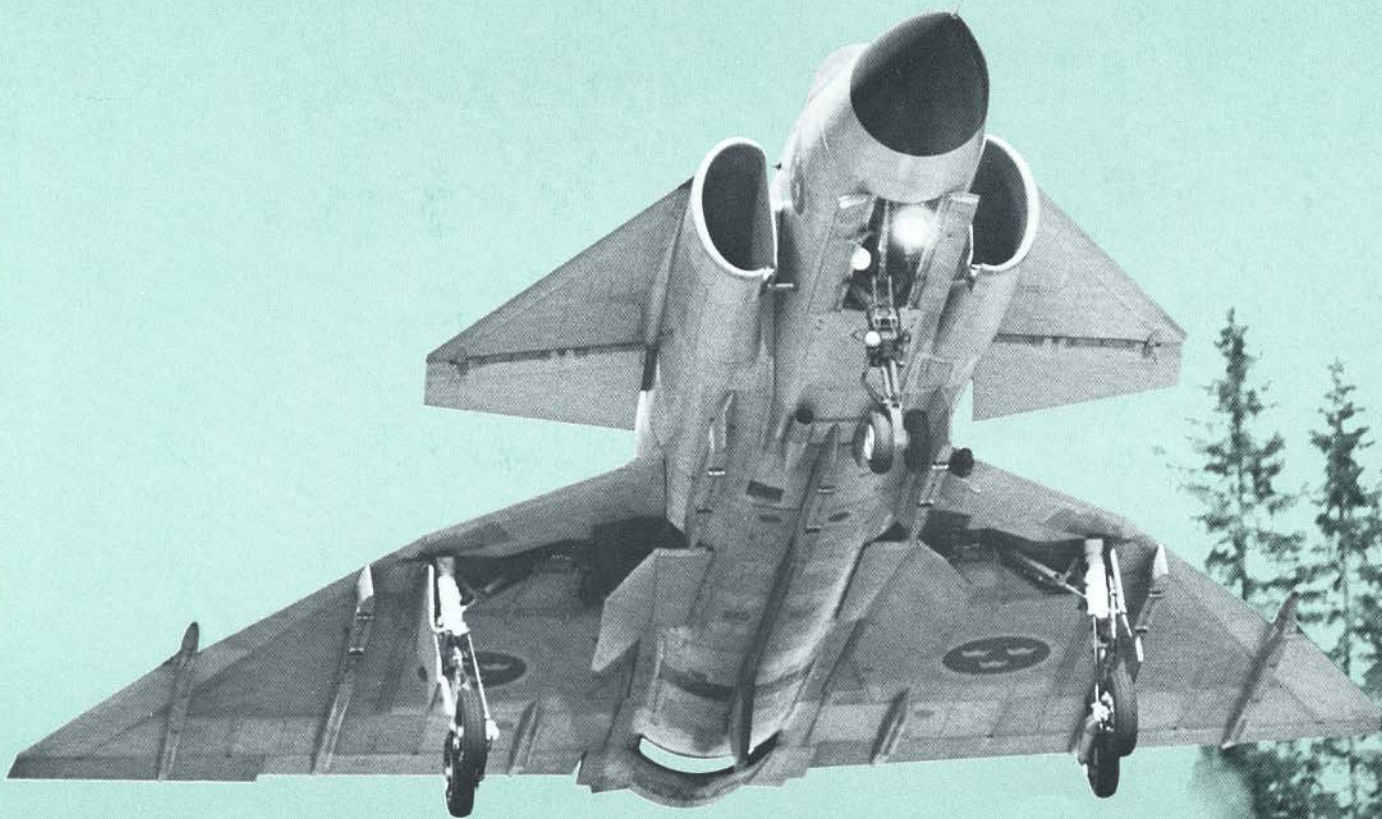

HEWLETT  PACKARD

For more information, call your local HP Sales Office or East (201) 265-5000 • Midwest (312) 677-0400 • South (404) 436-6181 • West (213) 877-1281. Or write: Hewlett-Packard, 1501 Page Mill Road, Palo Alto, CA 94304. In Canada: 275 Hymus Blvd., Point Claire, Quebec. In Europe: Hewlett-Packard, P.O. Box 85, CH-1217 Meyrin 2, Geneva, Switzerland. In Japan: Yokogawa-Hewlett-Packard, 1-59-1, Yoyogi, Shibuya-ku, Tokyo, 151.